



Structure Assembly & Care Guide

6m x 12m PE Marquee

Taking Care of Your Gala Tent™

Congratulations on purchasing your new Gala Tent™. Your Gala Tent™ will give you years of service and enjoyment if you follow these instructions carefully and take care of your Gala Tent™ correctly. Please read the instructions before attempting to erect your Gala Tent™ and save them for future reference.

Insurance

We highly recommend that your Gala Tent™ be insured against theft, adverse weather conditions and accidental damage. Damage caused by incorrect assembly will not be covered under the Manufacturer's warranty.

Check Your Equipment

Check the contents of the boxes in advance of using your Gala Tent™ for the first time. We would recommend that you check that you have all the components within 7 days of receipt of your goods and definitely before first use of your product. Ensure that you are familiar with the erect the Gala Tent™ and that all parts are accounted for. You should familiarise yourself with the tent including any restrictions it may have for your particular use. A Gala Tent™ is a transportable temporary structure, which under most circumstances will provide shelter against the elements. There are however extremes of weather for which allowance should be made.

Sustainability

Position: Sheltered
Weather: Fair/Moderate

Gala Tents™ are not guaranteed waterproof. We do however endeavour to make them as weatherproof as possible. Where necessary/possible we have welded the seams but on some seams this is not feasible. It is therefore possible that a small amount of leakage may occur in heavy rain. Treating all sewn seams with a seam sealant, which is available from Gala Tent, can prevent this. Tents are also renowned for condensation accruing inside, this usually happens over night and can be extreme in some cases so do not leave any goods inside overnight that can be affected by dampness.

Securing Your Gala Tent™

It is very important that this unit is secured against wind, we advise that the structure should be taken down if wind speeds exceed 30mph. We recommend the use of our tie down kits, Ground bar sets and ground bar pegs (optional). Although the unit is supplied with guide ropes and attachment points on the roof corners, we recommend that the unit be secured by attaching above optional equipment to the framework for added stability.

FIRE PRECAUTIONS

REMEMBER, YOUR GALA TENT™ CAN BURN. FOLLOW THESE COMMON SENSE RULES

- When erecting, ensure there is a minimum distance of 6 metres between other tent users.
- Do not place cooking, heating or lighting appliances near the sides or the panels canopy of the Gala Tent™.
- Always observe safety instructions for all appliances.
- Keep exits clear and unobstructed, use ramps for ground bars if necessary (optional item).

Dismantling Your Gala Tent™

Reverse the assembly instructions.

Take great care in windy conditions and ensure that you have enough help to prevent strain on the frame.

Dry all parts at the earliest opportunity. Do not put away wet.

Your Gala Tent™ is not covered under warranty if damage occurs due to incorrect dismantling, packing, storage or usage.

Storage

During long periods of inactivity and during the winter months, it is essential that the roof, walls and bungee straps are stored in a warm dry environment. Failure to do this may result in mildew damage to these parts; cold environments can be detrimental to your Gala Tent™ Marquee, especially the clear windows as they could fracture in adverse weather conditions.

The frame should also be stored in a completely dry environment. A light coating of petroleum jelly will help prevent corrosion, storage bags available as an option.

Please note: Your Gala Tent™ is not covered under warranty if it is stored incorrectly.

Cleaning

Roof and walls: Clean with a soft cloth or brush using mild detergent solution or soapy water and dry thoroughly.











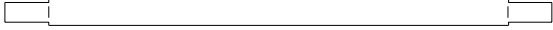

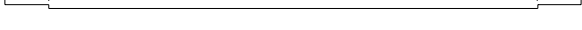







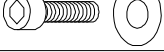

Frame: Brush of dirt and then wash with soapy water. Dry thoroughly.

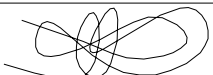
Spare Parts

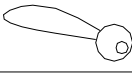
Should you damage or lose any parts of your Gala Tent™, spares are available from Gala Tent or your nearest stockist. **IMPORTANT:** Please note that storm, adverse weather and accident damage and damage through incorrect dismantle, packing and storage is not covered by warranty.

Gala Tent 6X12

-Parts List-

Quantity		Description
28	A 	Rafter
8	B1 	Apex and eave pole
4	B2 	Apex and eave pole
18	B3 	Apex and eave pole
14	C 	Leg
7	D1 	
7	D2 	
14		Base plate
6		3 way joint
4		4 way joint
15		3 way joint
10		4 way joint
14		Nut and bolt
7		Nut and bolt
14		Bolt
1		Spanner
4		Guy lines
130		Bolt
100		Bungee
4		Peg \varnothing 7x330mm
186		Peg \varnothing 4.5x180mm
2		End panel
12		Wall panel
1		Roof

Gala Tent 6X12

1

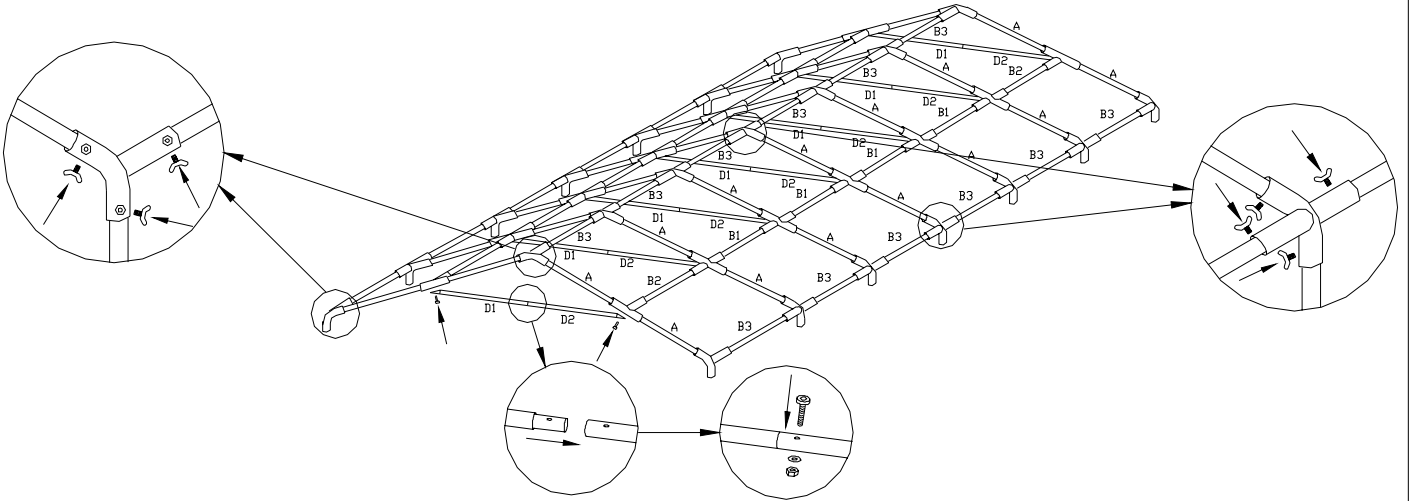

2

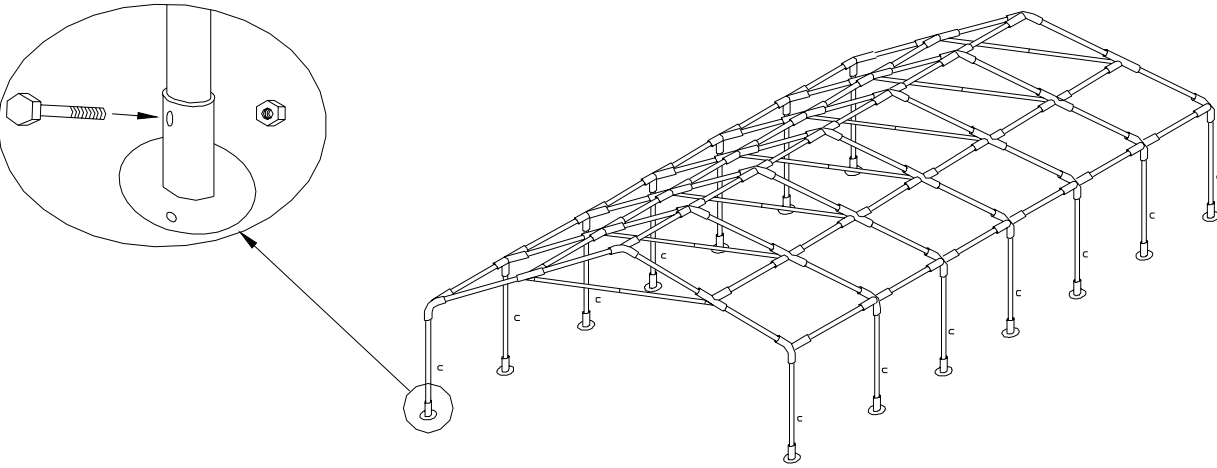

3

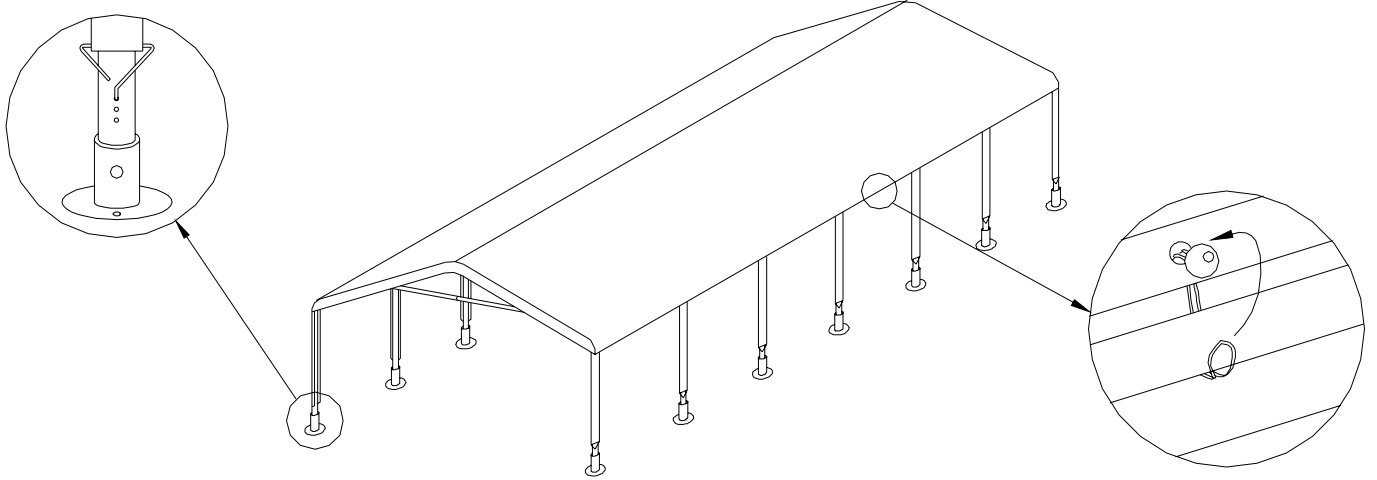

4

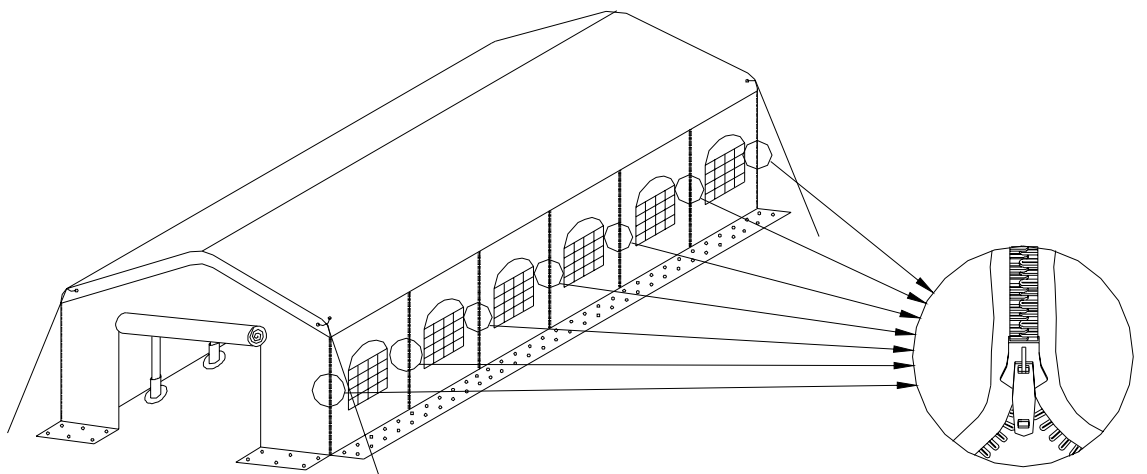

Structure Assembly

1. Lay out the roof poles and joints as seen on drawings. Ensure all parts are in their correct positions and then assemble roof frame, making sure the poles are xed tight into the joints as far as they can go, ignore holes in the poles these are not locating holes. 1b. Attach the locating joint screws (wing nuts), which secure the joints to the poles. (roof pole = B pole)

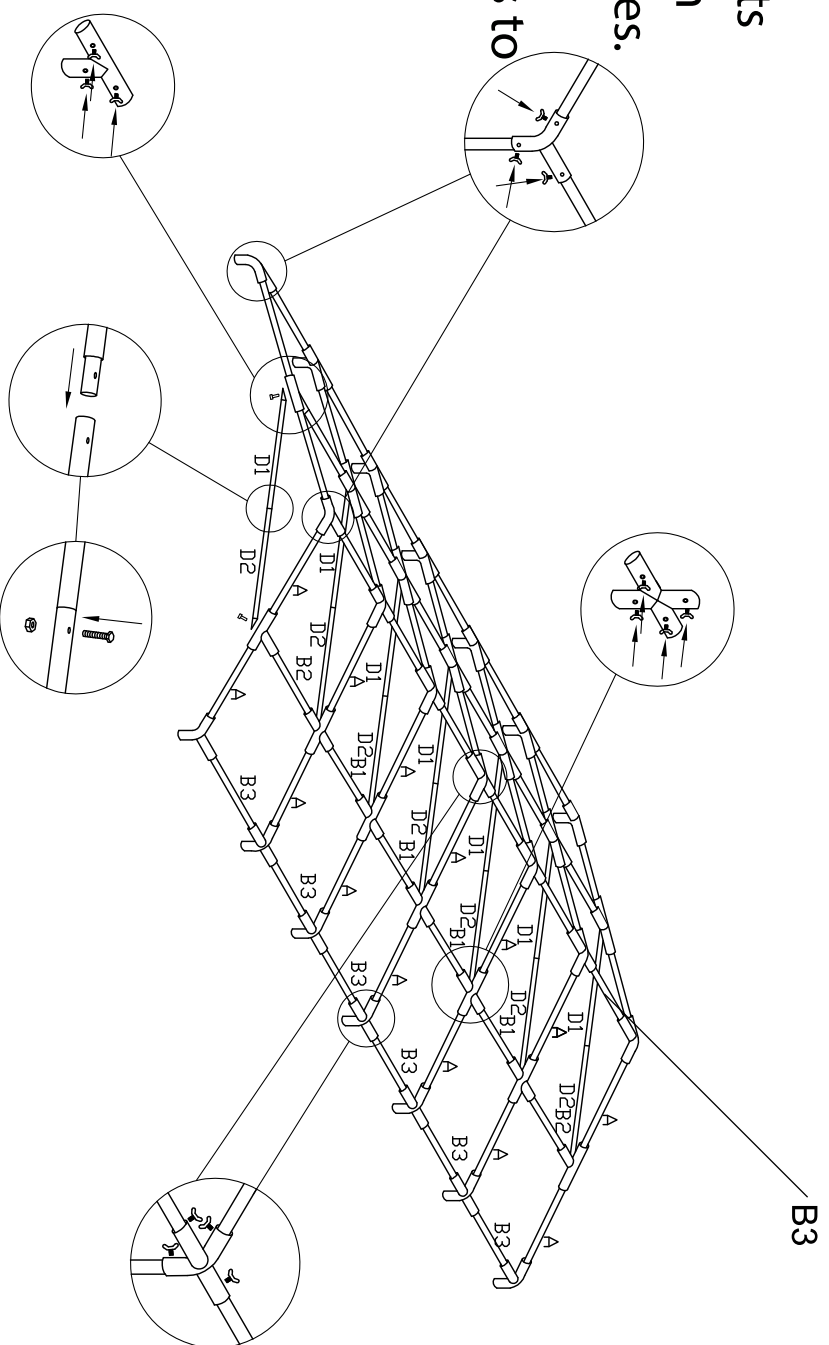

Structure Assembly

1. Lay out the roof poles and joints as seen on drawings. Ensure all parts are in their correct positions and then assemble roof frame, making sure the poles are tight into the joints as far as they can go, ignore holes in the poles these are not locating holes. 1b.

Attach the locating joint screws (wing nuts), which secure the Joints to the poles.

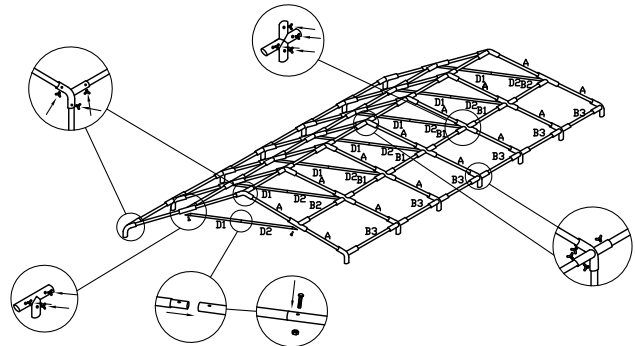

2. Lay the roof cover over the frame and attach using the elastic bungee toggle straps provided.

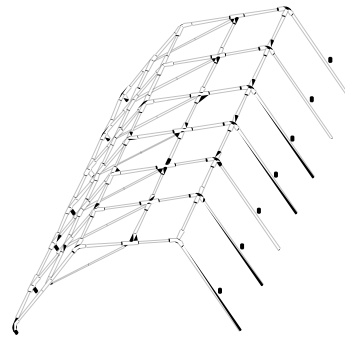

3. Using the required number of people, lift one side of the Gala Tent™ and insert the legs. Ensure that the holes in the poles are placed towards the bottom as the leg cover clips to these.



4. If you intend to use the end wall panels it is easier to attach these now, before the Gala Tent™ is at full height unless you have steps.

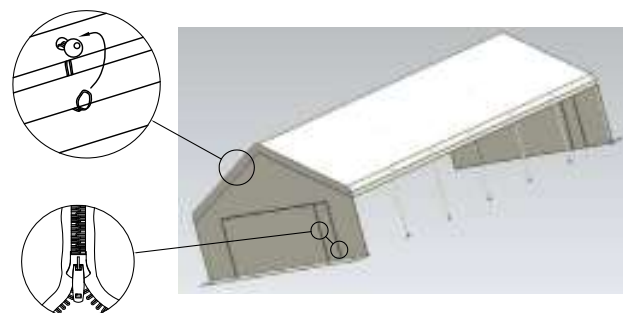

5. Lift the other side of the roof section and attach the legs. Attach the pedestal feet to the bottom of all the legs using the nuts and bolts provided.

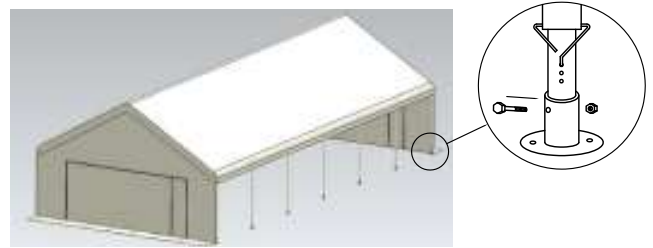

6. Attach the sidewalls to every bar framework using the elastic bungee toggle straps, Velcro attached to leg poles, zips or dutch lacing, tie the side walls together providing wind proof enclosure

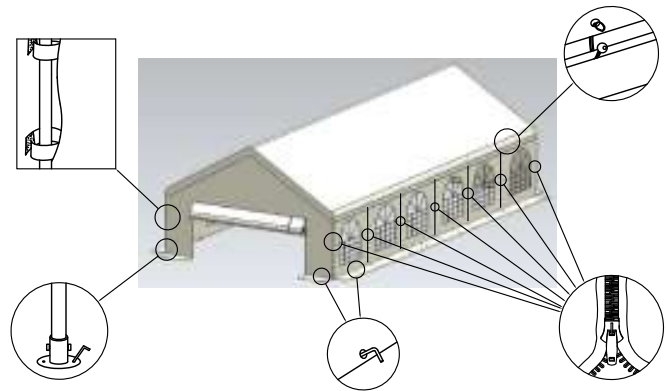

7. Attach the canopy to every bar framework using the elastic bungee toggle straps, Velcro attached to roof canopy and frame tying the structure together providing wind proof enclosure

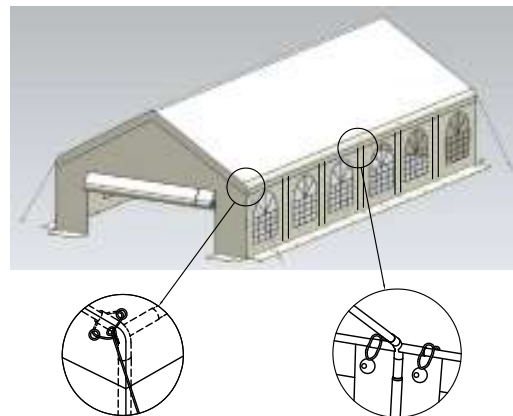

IT IS IMPORTANT THAT YOU TAKE CARE IN WINDY WEATHER CONDITIONS. IT MAY BE NECESSARY TO TIE DOWN YOUR GALA TENT™ AT ANY STAGE DURING THE ASSEMBLY

1. Peg down sidewalls to ground or attach to the ground bar the bottom of each side and end wall. (Ground bar set optional extra)

2. Secure and level your structure with tie down kits and weights as necessary.

3. If you are still unsure of how to erect you Gala Tent there is a assembly video online for guidance at http://www.galatent.co.uk/marquee_movies.asp

Accessories For Your Gala Tent™

The products below can be purchased direct from Gala Tent Limited™

Marquee Ratchet Tie Down Kits

These are ratchet straps (2 straps per kit) which run internally from the eave poles to a 12" heavy-duty stake. They eliminate the need for external guide ropes and are suitable for soft ground conditions. The number shown in the Tie Down Kit column is the recommended quantity per structure.



Gala Tent Ground Bar Sets

These easy to attach ground bar sets, give your marquee added stability, especially when used on hard standings or soft ground surfaces, a recommended accessory.



Globe Lighting Set

These outdoor globe light sets are ideal for outdoor events and special occasions, suitable to hang from a marquee, gazebo, garden furniture, patios, parasols etc.



Gala-Tex Flooring

Low price durable outdoor flooring, ideal for all event walkways inside and outside marquees seen at shows and exhibitions all over Britain, comes cut to size or on a roll.



Event Tables

A large range of event and banquet tables in wood and blow mould, from 3ft to 6ft, our range includes poser, square, rectangle and round tables, catering for all event needs.



Event Chairs

A stylish range of space saving folding chairs suitable for residential commercial use or hire.



Storage Bags

Low cost good quality storage bags for poles, sidewalls and canopies.



Event Heating

A range of marquee, parasol and patio heaters with special featured attachments, which either x to the wall, clamp to marquee framework or hang from a parasol.



More Structures from Gala Tent™

The Original Gala Tent PE

Available in over 17 different sizes from 2m x 3m to 6m x 12m
You can now purchase an add on extension bay to extend your existing Gala Tent and make a bigger area.



Gala Tent Lining

Photo showing how 3m and 4m Gala tents look featuring lining. Turn your occasion in to a spectacular event with our re rated very aordable quality ivory satin linings.



The New PVC Gala Tent

Featuring new 650g PVC materials featuring wave drape design and galvanised framework, available in over 17 different sizes from 2m x 3m to 6m x 12m. Available in White.



Check out the new 6m modular linings in this photo on the right.



Gala Shade Pro-MX

The new Gala Shade Pro-MX has been specially designed to meet the requirements of the commercial market. It has an easy-up fast build mechanism and can be quickly erected by two people. Totally portable, Gala Shade Pro-MX is extremely robust and durable to withstand the bump and grind of regular use. Steel 1.2mm framework, 500g roof and optional sidewalls, available in many different colours and sizes, along with printing and branding service.



Gala Shade Pro-40

Gala Shade Pro-40 is Gala's mid range heavy-duty gazebo for commercial applications. Quality build the design balances exceptional durability and strength, practicality and value-for-money. Aluminium 1.8mm 40mm hexagonal framework, 500g roof and optional sidewalls, available in many different colours and sizes, along with printing and branding service.



Gala Shade Pro-50

Gala Shade Pro-50 is Gala's top of the range heavy-duty gazebo for commercial applications. Quality build the design balances exceptional durability and strength, practicality and value-for-money. Aluminium 2mm 50mm hexagonal framework, 500g roof and optional sidewalls, available in many different colours and sizes, along with printing and branding service.



9m x 9m Gala Fusion

The frames of clearspan Gala Fusion structures are manufactured from high-grade aluminium extrusions to provide strength whilst minimising weight; there is no need for centre supports or guide ropes. Gala Tent Fusion can be located on most surfaces including tarmac, concrete and grass. The lightweight frame makes Gala Tent Fusion quick, simple and safe to erect with no special skills or tools required. Packs down to fit on an oversized pallet for easy transportation, also available in 3m, 4m and 6m with add on bays.



Gala Tent Modular

Bespoke - manufactured to any size of your requirements

The clearspan high-reinforced aluminium framed marquee

* Canopy is made of 750g/ M2 blackout PVC-coated polyester textile.

* Sidewalls are made of 650g/M2 translucent PVC-coated polyester textile.

* Flame retardant



Contact Information

Address

Unit 10 Farfield
Park Manvers Way
Wath-Upon-Dearne
Rotherham
South Yorkshire
S63 5DB

Contact Telephone

0800 988 4252
0871 423 4252



For more information visit us

www.galalent.co.uk

