

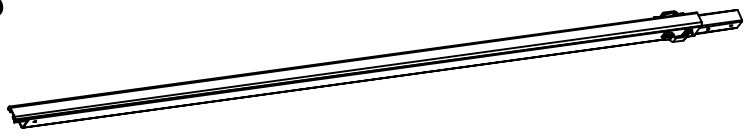





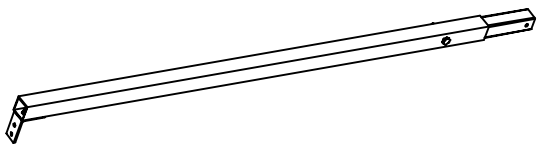
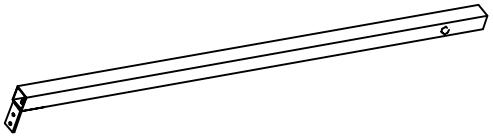
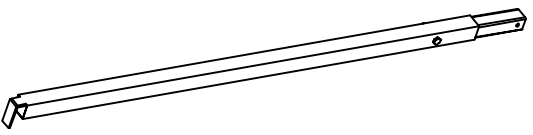
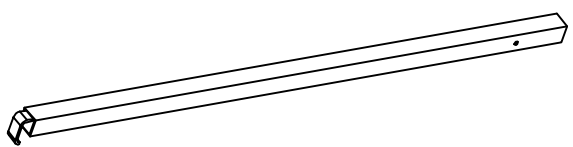

# GALA TENT 9x3M ADD ON BAY

## -Parts List-

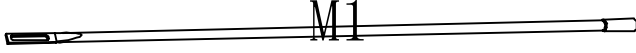
Quantity		Description
2	A 	Leg
2	B 	Roof beam 1
2	C 	Roof beam 2
2	H 	Eaves rail 1
2	I 	Eaves rail 2
3	J 	Purlin 1
3	K 	Purlin 2

# GALA TENT 9x3M ADD ON BAY

## -Parts List-

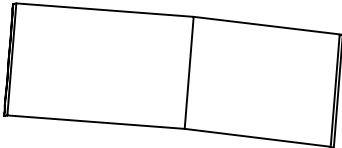
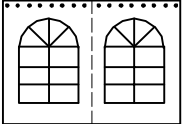
Quantity		Description
4	M 	Sidewall downside rail
	0 M8x90 2个      M8x65 6个  M8x70 4个      M8x55 8个	Accessories
2	0  Footplate	
2	0  Corner connector	
1	0  Top connector	
2	0 Sidewall Wire	
24	 plastic tai lam	Cover
1	P 	
2	R 	Sidewall

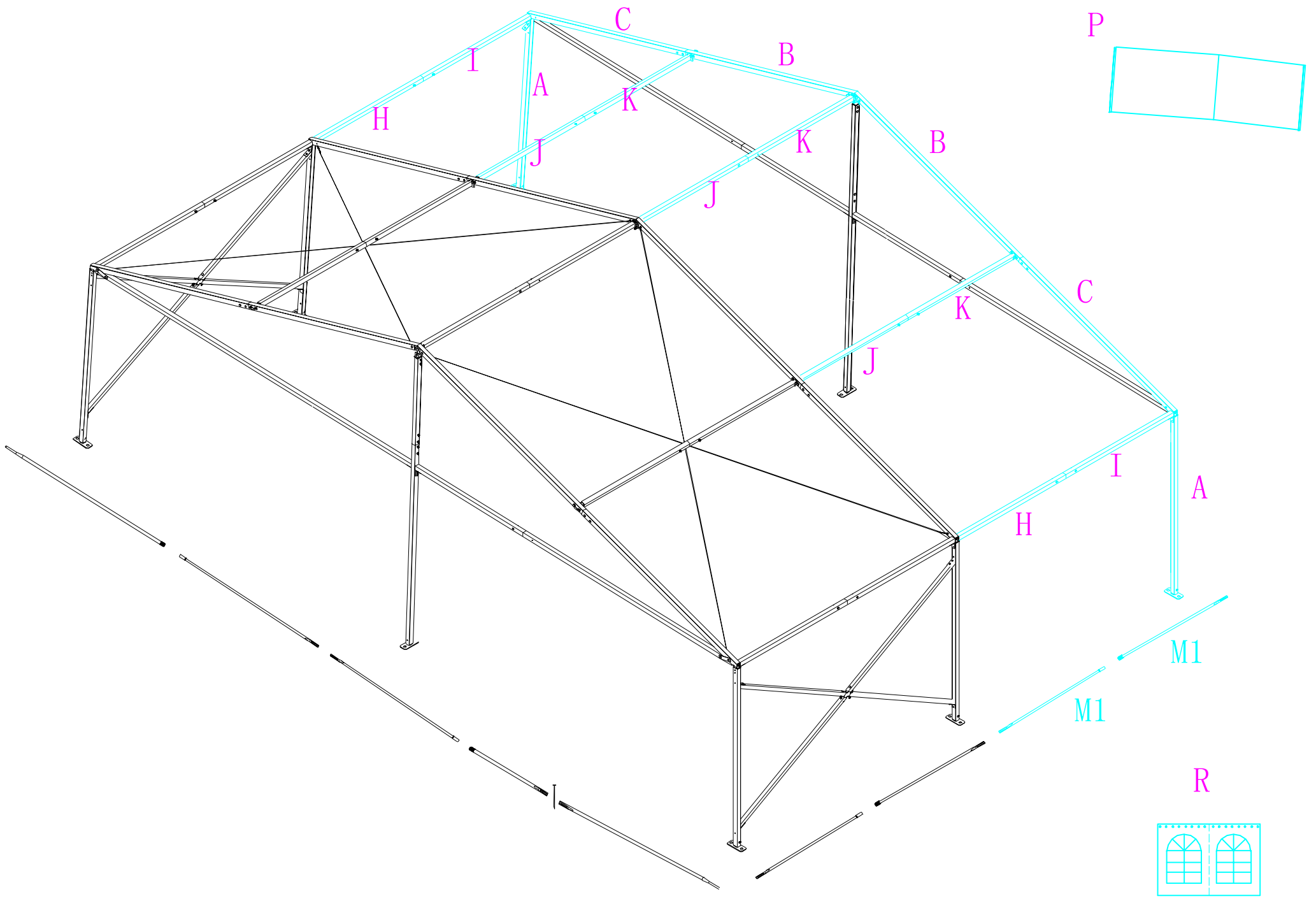

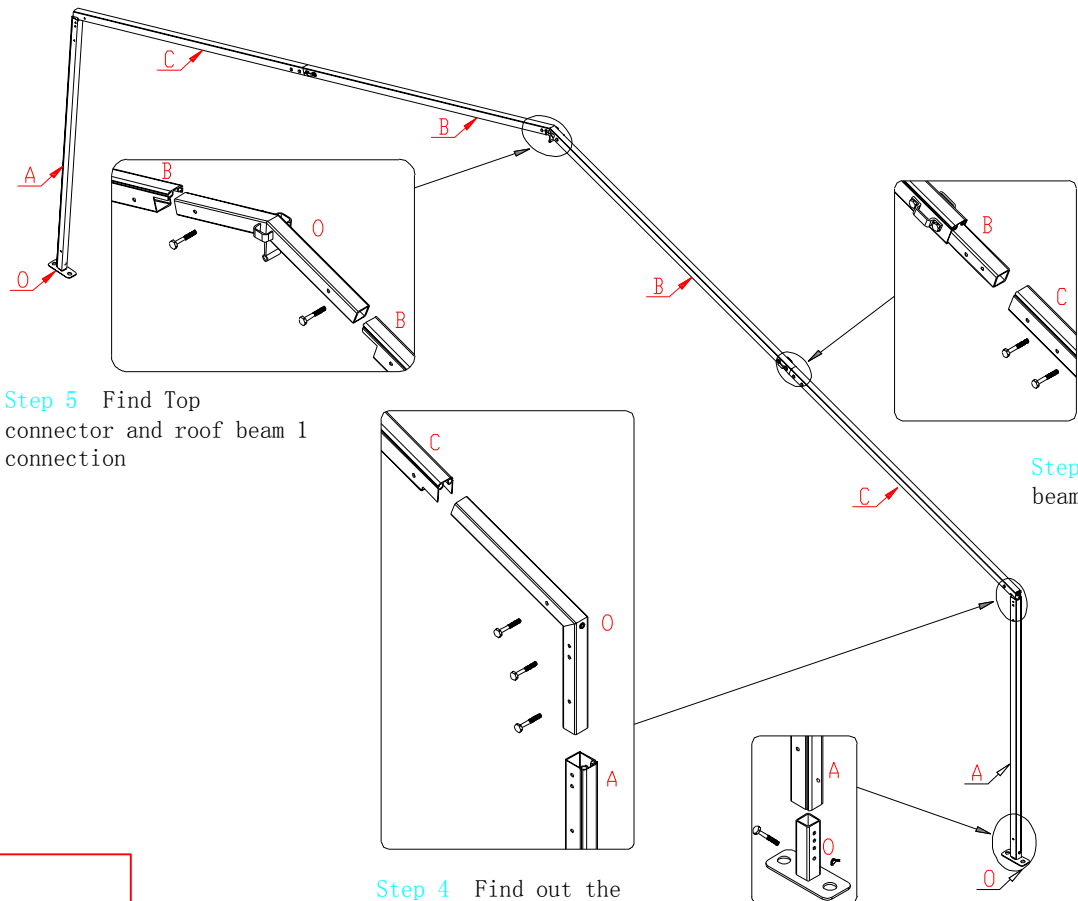

Step 5 Find Top connector and roof beam 1 connection

Step 3 Connect the roof beam 1 and roof beam 2

Step 4 Find out the Corner connector and leg, Roof beam 2 connections

Step 2 Find out the Leg and foot plate connection

Step 1 Find out the Foot plate



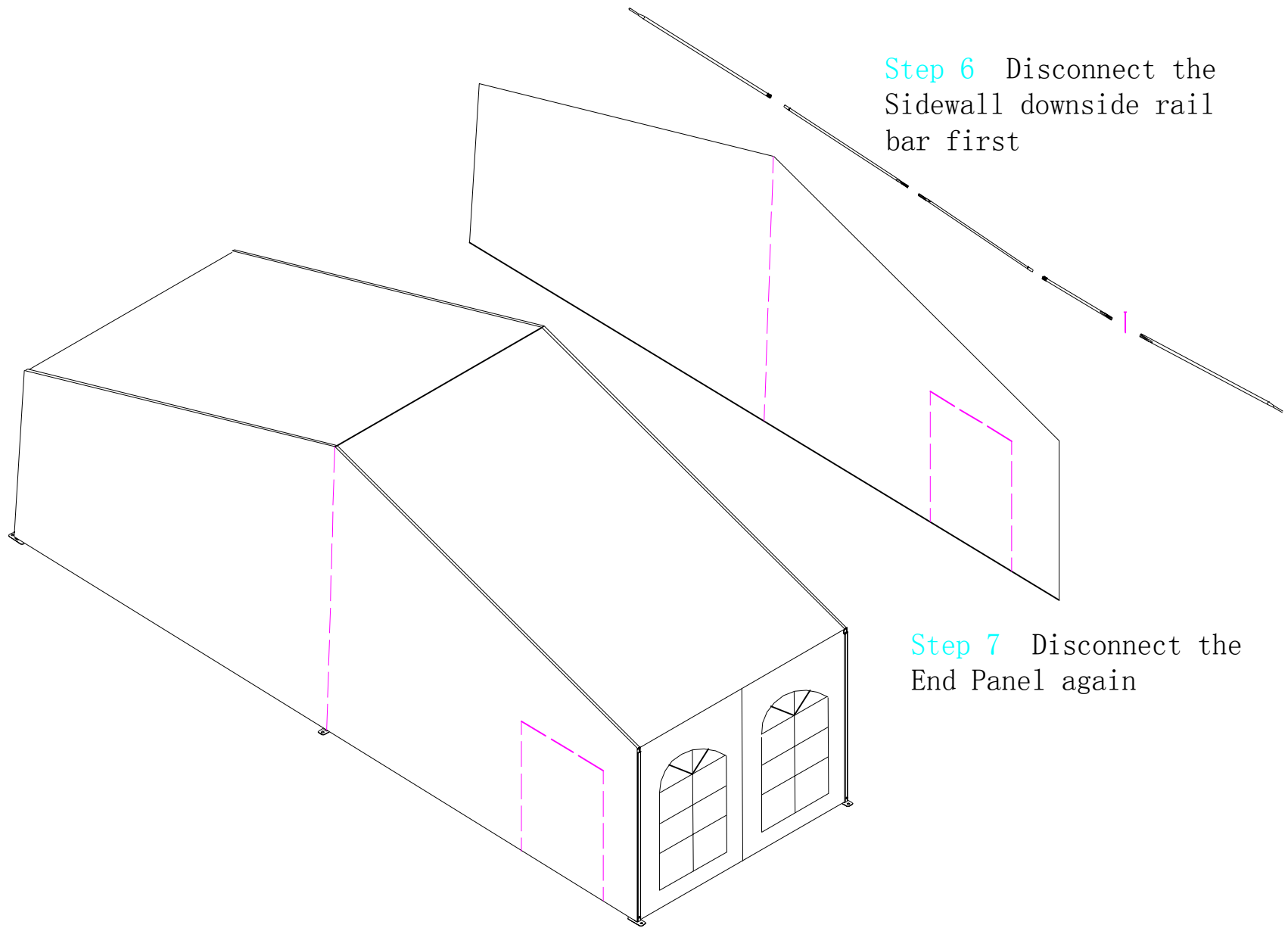

Step 6 Disconnect the Sidewall downside rail bar first

Step 7 Disconnect the End Panel again

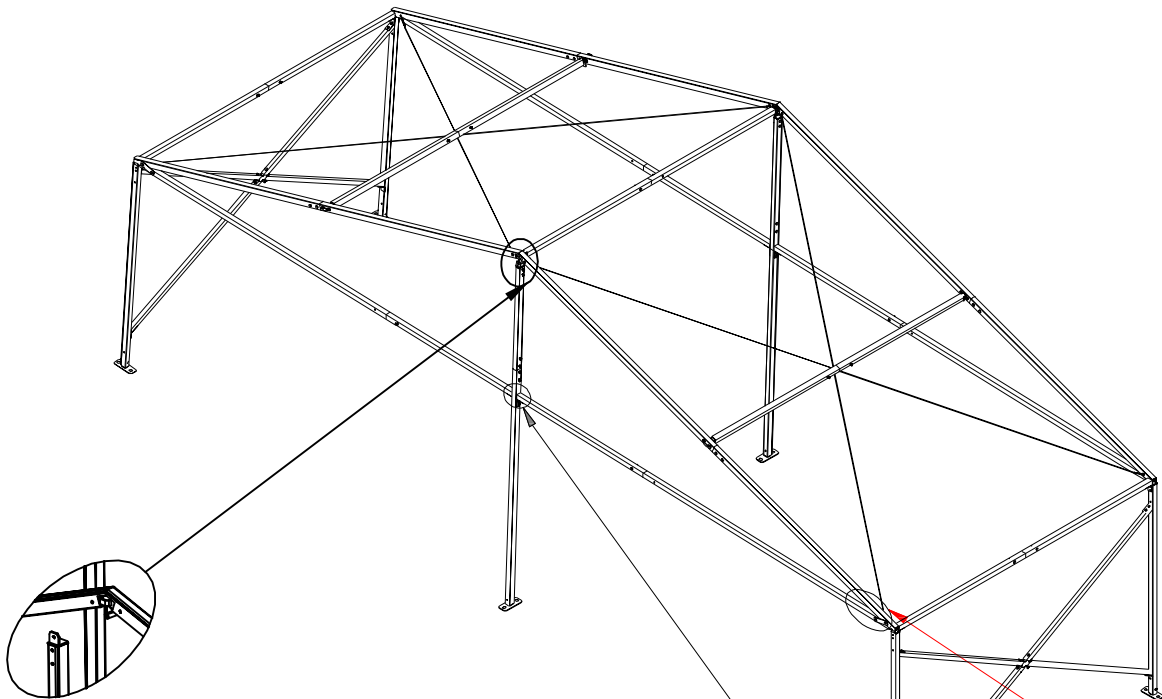

Step 10 To tear down the Gable pole

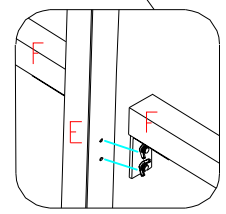

Step 9 To tear down the side eaves rail

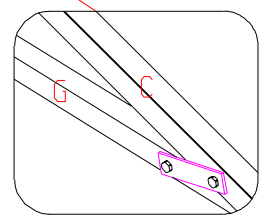

Step 8 To tear down the side beams fittings

Step 14 Perlin and roof beam connections

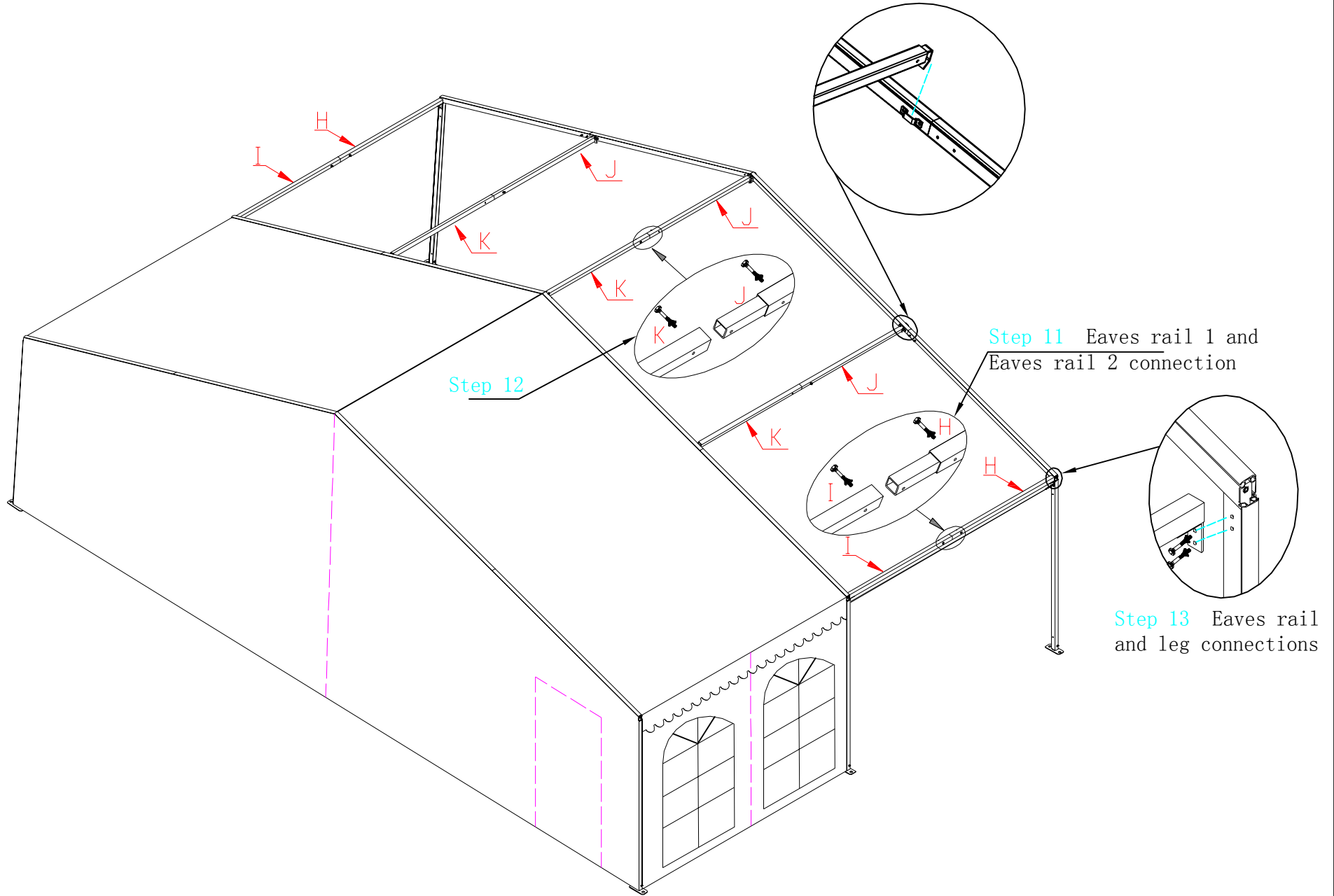

Step 16 Side eaves and gable pole connections

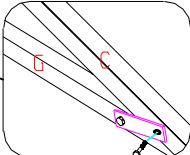
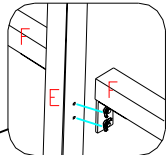

Step 15 Side eaves and gable pole connections

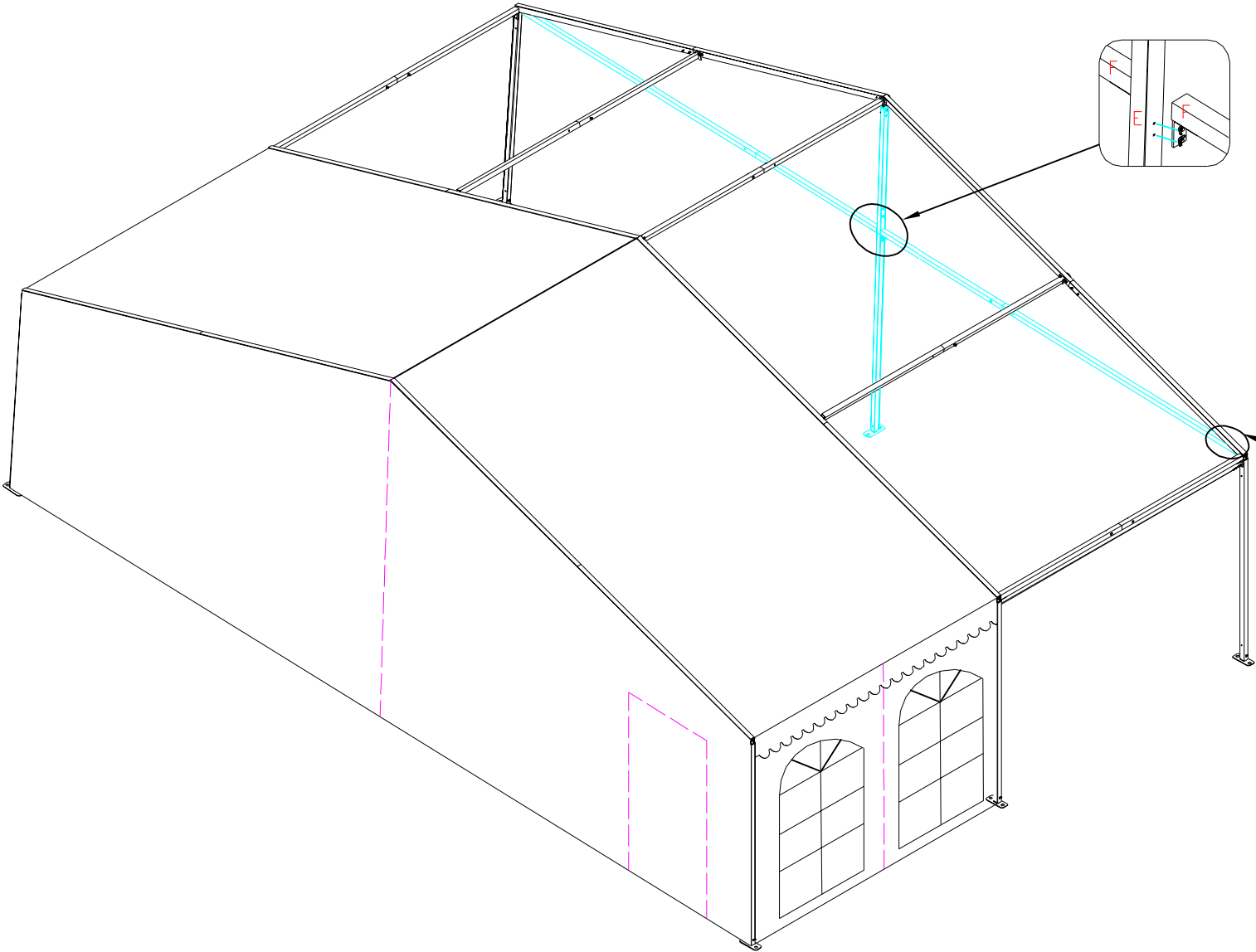



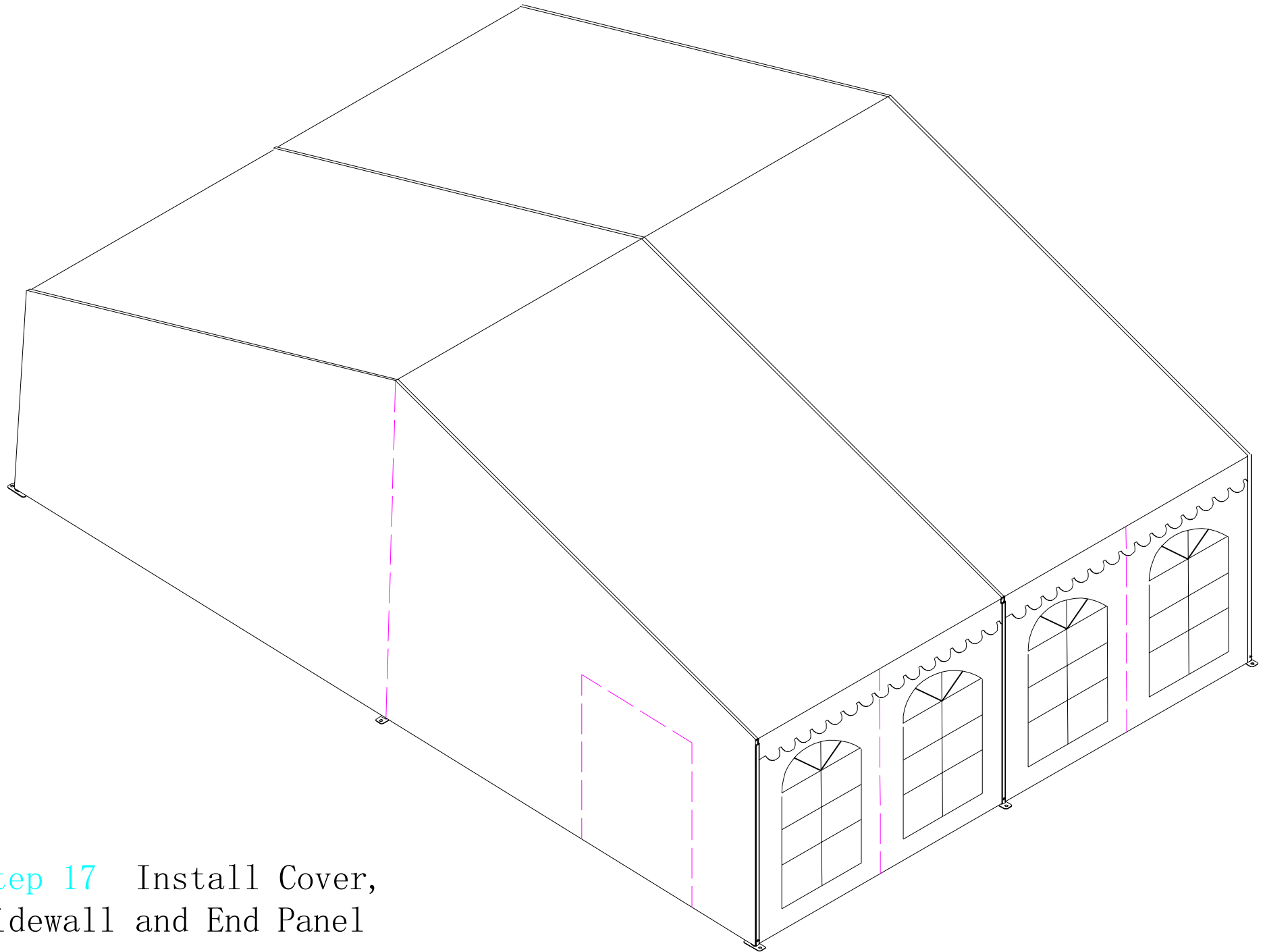

Step 17 Install Cover,  
Sidewall and End Panel

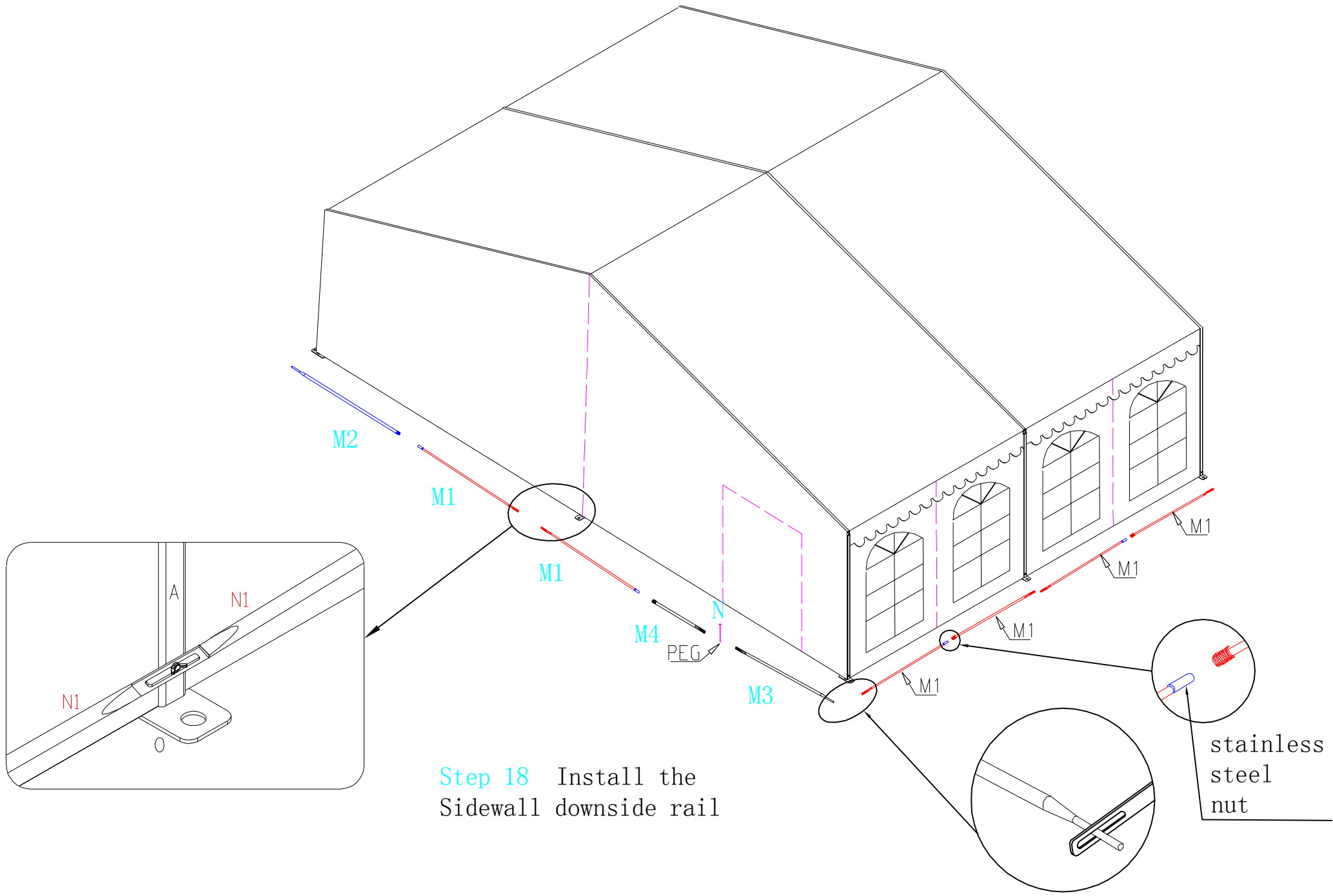

Step 18 Install the Sidewall downside rail

stainless steel nut

PEG

N1

A

N1

M2

M1

M1

M4

N

M3

M1

M1

M1

M1

stainless steel nut

PEG

N1

A

N1

M2

M1

M1

M4

N

M3

M1

M1

M1

M1

stainless steel nut

PEG