



Structure Assembly & Care Guide

**9m x 3m Fusion Tent
Master Bay**

Taking Care of Your Gala Tent™

Congratulations on purchasing your new Gala Tent™. Your Gala Tent™ will give you years of service and enjoyment if you follow these instructions carefully and take care of your Gala Tent™ correctly. Please read the instructions before attempting to erect your Gala Tent™ and save them for future reference.

Insurance

We highly recommend that your Gala Tent™ be insured against theft, adverse weather conditions and accidental damage. Damage caused by incorrect assembly will not be covered under the manufacturers warranty.

Check Your Equipment

Check the contents of the boxes in advance of using your Gala Tent™ for the first time. We would recommend that you check that you have all the components at within 7 days of receipt of your goods and definitely before first use of your product. Ensure that you are familiar with the erecting of the Gala Tent™ and that all parts are accounted for. You should familiarise yourself with the tent including any restrictions it may have for your particular use. A Gala Tent™ is a transportable temporary structure, which under most circumstances will provide shelter against the elements. There are however extremes of weather for which allowance should be made.

Sustainability

Position: Sheltered
Weather: Fair/Moderate

Gala Tents™ are not guaranteed waterproof. We do however endeavour to make them as weatherproof as possible. Where necessary/possible we have welded the seams but on some seams this is not feasible. It is therefore possible that a small amount of leakage may occur in heavy rain. Treating all sewn seams with a seam sealant, which is available from Gala Tent, can prevent this. Tents are also renowned for condensation accruing inside, this usually happens over night and can be extreme in some cases so do not leave any goods inside overnight that can be affected by dampness.

Securing Your Gala Tent™

It is very important that this unit is secured against wind, we advise that the structure should be taken down if wind speeds exceed 55mph. We recommend the use of our tie down kits, Ground Bar sets and ground bar pegs (optional). Although the unit is supplied with guide ropes and attachment points on the roof corners, we recommend that the unit be secured by attaching above optional equipment to the framework for added stability.

FIRE PRECAUTIONS

REMEMBER, YOUR GALA TENT™ CAN BURN. FOLLOW THESE COMMON SENSE RULES

- When erecting, ensure there is a minimum distance of 6 metres between other tent users.
- Do not place cooking, heating or lighting appliances near the sides or the roof of the Gala Tent™.
- Always observe safety instructions for all appliances.
- Keep exits clear and unobstructed, use ramps for ground bars if necessary (optional item).

Dismantling Your Gala Tent™

Reverse the assembly instructions.

Take great care in windy conditions and ensure that you have enough help to prevent strain on the frame.

Dry all parts at the earliest opportunity. Do not put away wet.

Your Gala Tent™ is not covered under warranty if damage occurs due to incorrect dismantling, packing, storage or usage.

Storage

During long periods of inactivity and during the winter months, it is essential that the roof, walls and bungee straps are stored in a warm dry environment. Failure to do this may result in mildew damage to these parts; cold environments can be detrimental to your Gala Tent™ Marquee, especially the clear windows as they could fracture in adverse weather conditions.

The frame should also be stored in a completely dry environment. A light coating of petroleum jelly will help prevent corrosion, storage bags available as an option.

Please note: Your Gala Tent™ is not covered under warranty if it is stored incorrectly.

Cleaning













Roof and walls: Clean with a soft cloth or brush using mild detergent solution or soapy water and dry thoroughly.









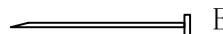

Frame: Brush of dirt and then wash with soapy water. Dry thoroughly.

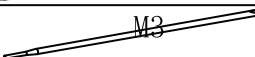
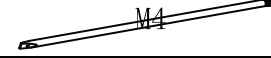
Spare Parts

Should you damage or lose any parts of your Gala Tent™, spares are available from Gala Tent or your nearest stockist. **IMPORTANT:** Please note that storm, adverse weather and accident damage and damage through incorrect dismantle, packing and storage is not covered by warranty.

Gala Tent 9x3 Mase B

Quantity		Description
4	A 	Leg
4	B 	Roof beam 1
4	C 	Roof beam 2
2	D 	Gable pole (up)
2	E 	Gable pole (down)
4	F 	Side eaves rail 1
4		Side eaves rail 2
2		Eaves rail 1
2	I 	Eaves rail 2
3		Purlin 1
3		Purlin 2
8	L 	Scissers

Quantity		Description
8	M 	Sidewall downside rail
2		
2	M 	
2	M 	
2	M 	
0	M8x90 6□ M8x65 18□ M8x70 4□ M8x55 18□ 	Accessories
6	0  Footplate	
4	0  Corner connector	
2 2	0  Top connector  X way connector	
4	0 Roof Cover Wire	
2	0 Sidewall Wire	
12		Cover plasti tai
2		End Panel
2		Sidewall

Components On Structure

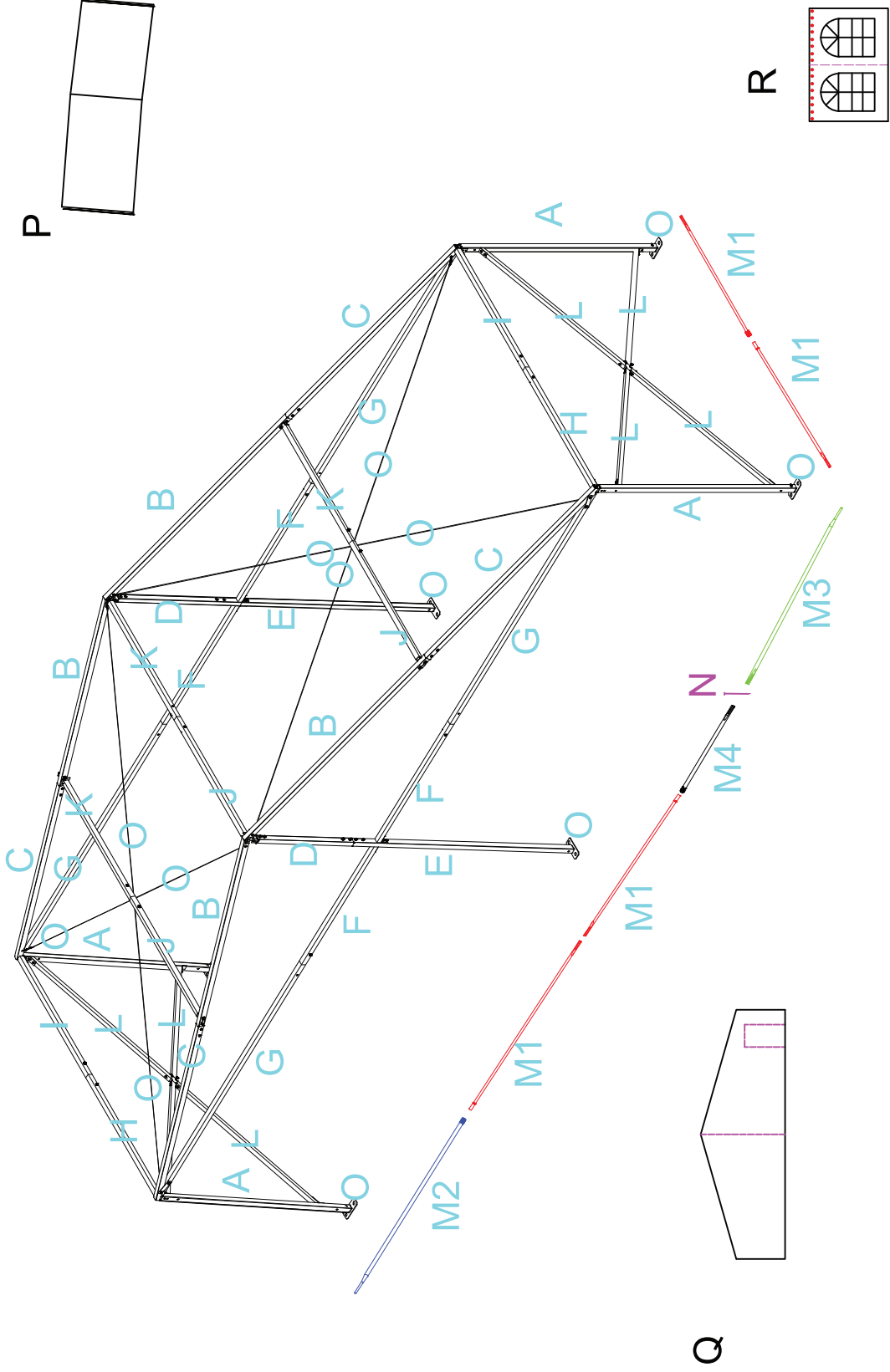

Structure Assembly

STAGE 1 - Take out all frame parts from packaging. Find parts A,B,C,O. Fix beam A,B,C as illustration and steps show. Then fixing the beams using O completing 1 span. then repeat above step to build spans. Build all of this section on the ground on its side.

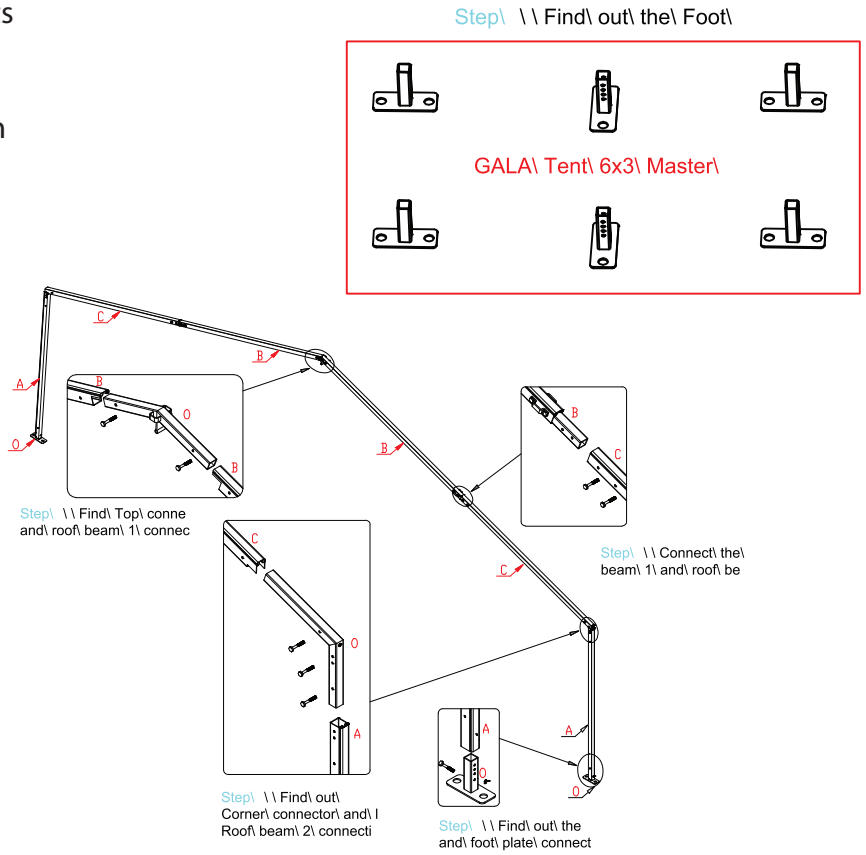

STAGE 2 - Find parts L shown in diagram. Connect scissors L with all 4 connectors supplied. Then connect span to main frame as shown on main illustration. attach the L poles while Stage 1 is still on the floor.

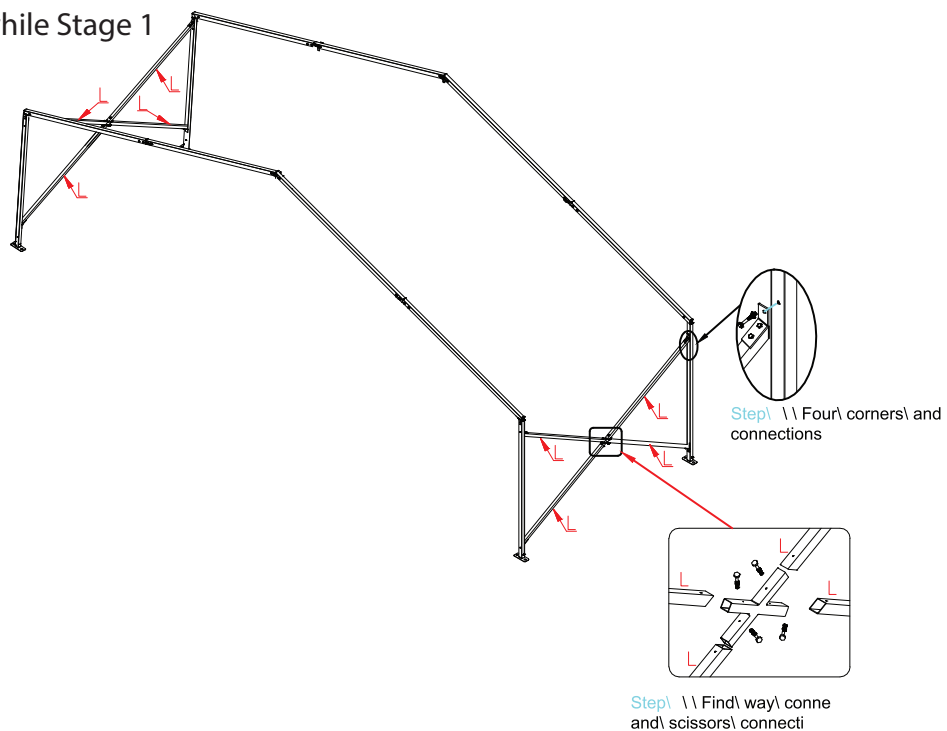

STAGE 3 - Find parts J,K,H,I.
 Connect purlin K and J with bolts,
 then doing the same with H and
 I. Connect siccors H with all 4
 connectors supplied. Then
 connect span to main frame as
 shown on main illustration.

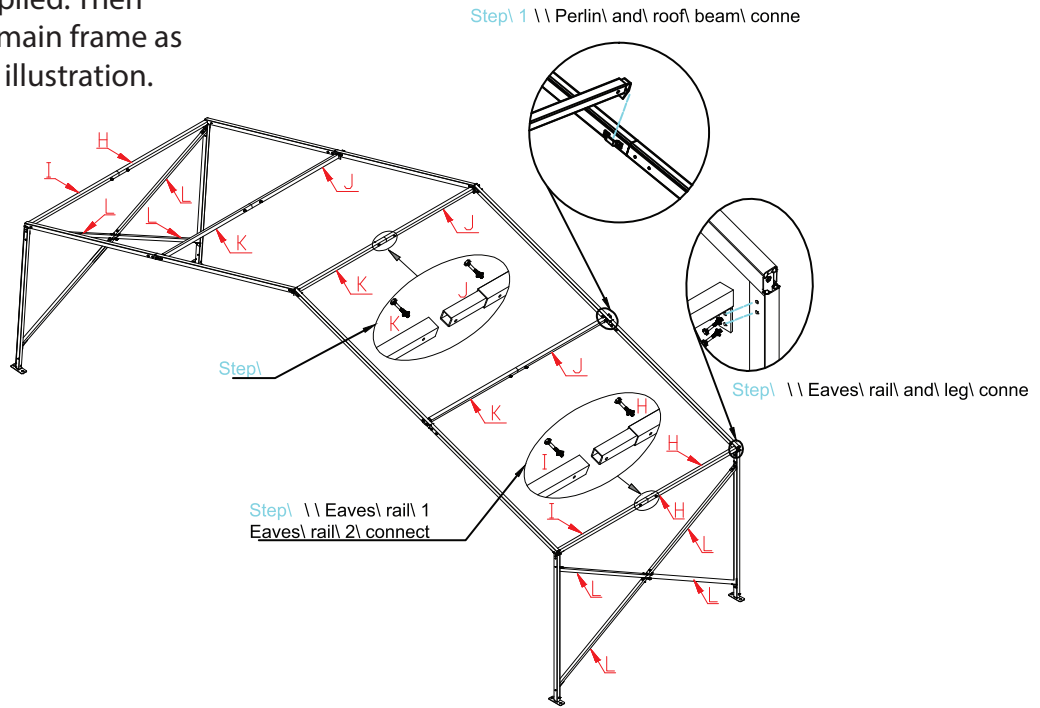

STAGE 4 - Find roof cover wire
 and install as below. Making
 sure that it is secure and in the
 correct position and is not
 tangled.

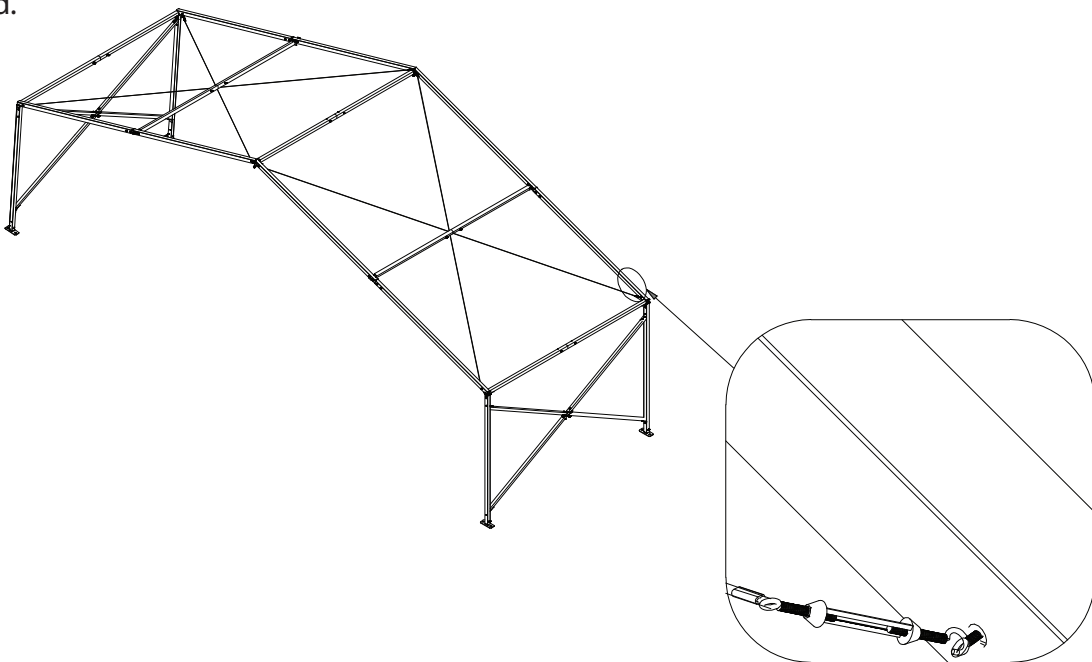

Step 11 Installation of Roof Cover Wire, elastic adjustment screws

STAGE 5 - Find parts D,E. Connecting gable pole with a foot plate.

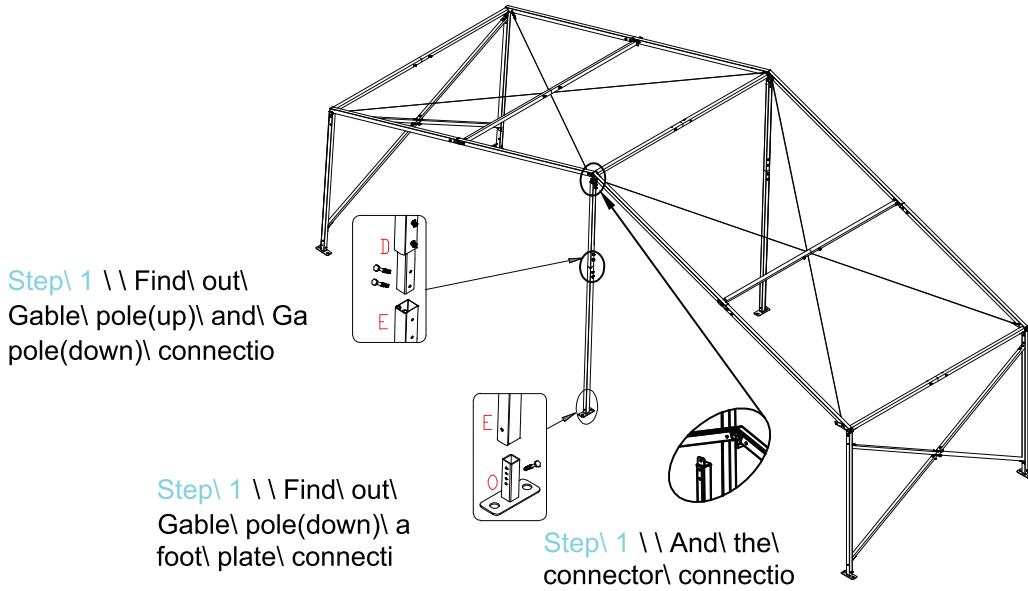

STAGE 6 - Connect side eave rail F,G to E by using bolts, installing in the same way as the illustration shows.

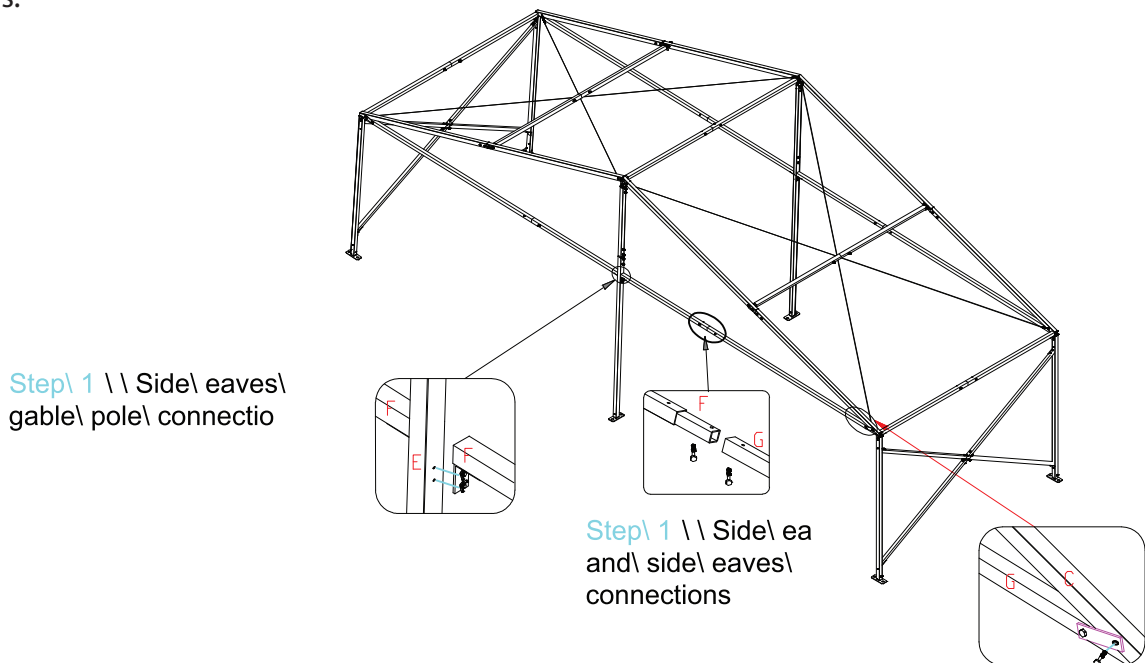

STAGE 7 - Before fitting the panels ensure that the frame is square and anchor down the feet. Tie the ropes to the corners of the roof panel at one end. Throw ropes over the full structure. Feed the roof panel into the roof channels. Pull the ropes evenly, until the roof panel is completely through.

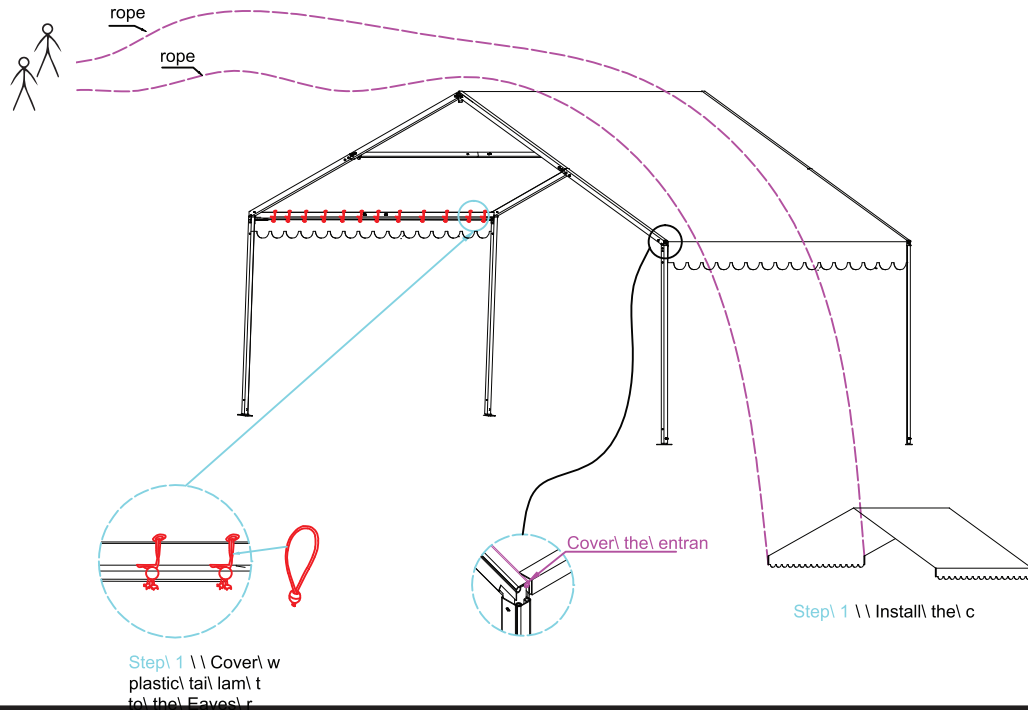

STAGE 8 - Thread the side wires through the eyelets at the top of the window panels. Hook the end of the wire to the eye nut which screws into the frame at each side. Then use the tensioning wire to tighten it.

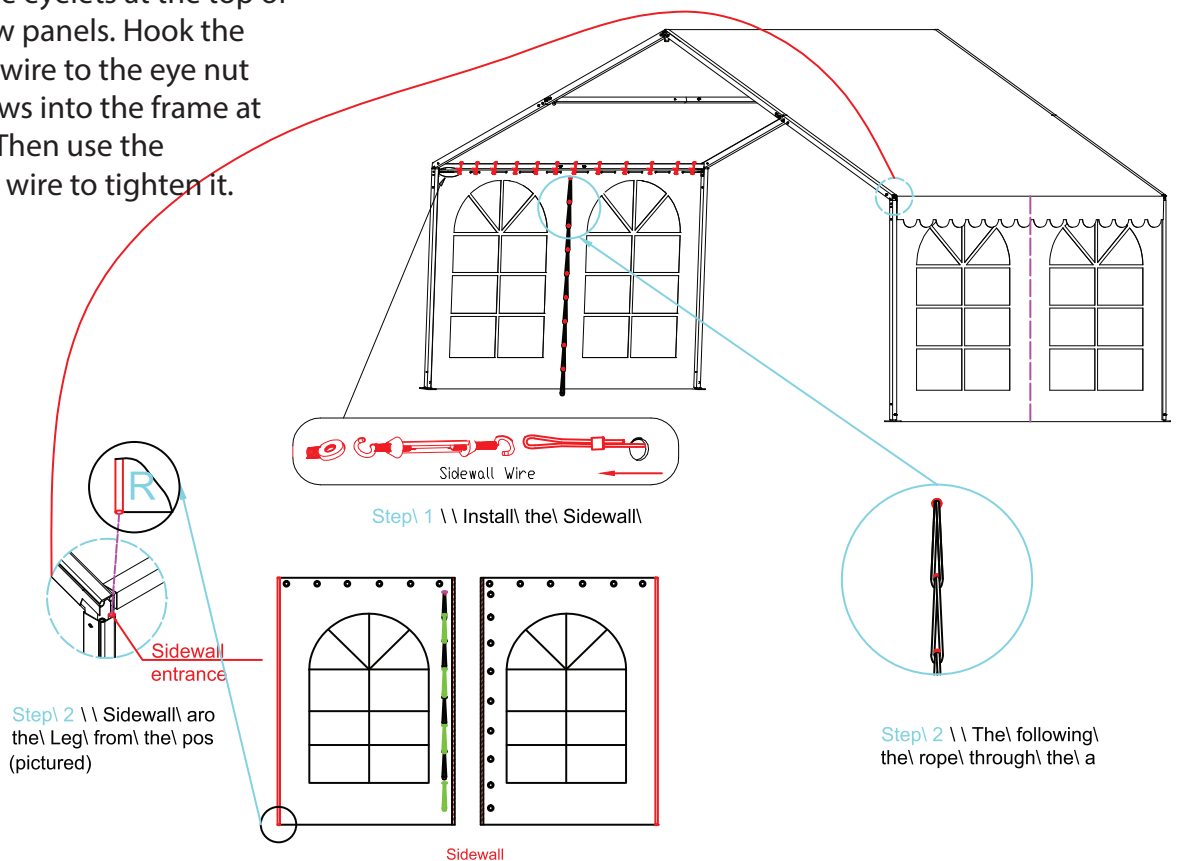

STAGE 9 - Slide wall into lip on roof as done with roof. Slowly push the wall through the groove until complete then secure with toggles.

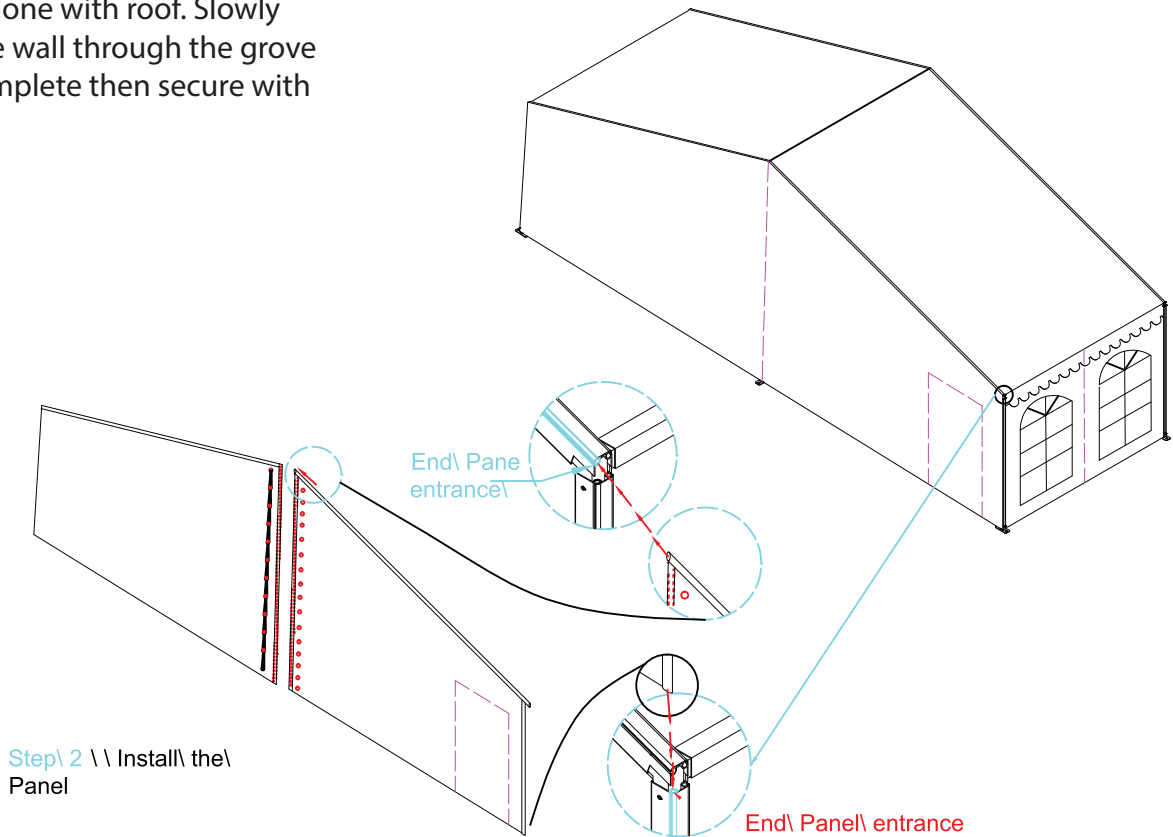

STAGE 10 - Slide ground bar M into sleeve on wall and bolt to frame securing the wall.

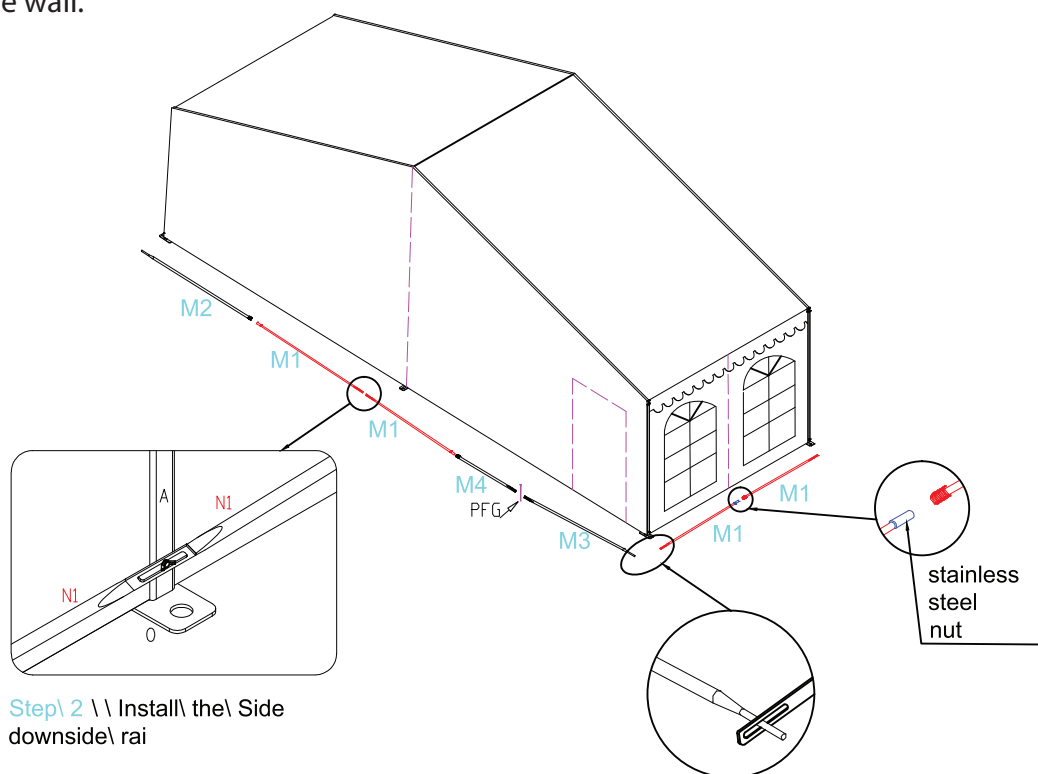

Accessories For Your Gala Tent™

The products below can be purchased direct from Gala Tent Limited™

Marquee Ratchet Tie Down Kits

These are ratchet straps (2 straps per kit) which run internally from the eave poles to a 12" heavy-duty stake. They eliminate the need for external guide ropes and are suitable for soft ground conditions. The number shown in the Tie Down Kit column is the recommended quantity per structure.



Gala Tent Ground Bar Sets

These easy to attach ground bar sets, give your marquee added stability, especially when used on hard standings or soft ground surfaces, a recommended accessory.

Globe Lighting Set

These outdoor globe light sets are ideal for outdoor events and special occasions, suitable to hang from a marquee, gazebo, garden furniture, patios, parasols etc.

Gala-Tex Flooring

Low price durable outdoor flooring, ideal for all event walkways inside and outside marquees seen at shows and exhibitions all over Britain, comes cut to size or on a roll.



Event Tables

A large range of event and banquet tables in wood and blow mould, from 3ft to 6ft, our range includes poser, square, rectangle and round tables, catering for all event needs.



Event Chairs

A stylish range of space saving folding chairs suitable for residential commercial use or hire.



Storage Bags

Low cost good quality storage bags for poles, sidewalls and canopies.



Event Heating

A range of marquee, parasol and patio heaters with special featured attachments, which either fix to the wall, clamp to marquee framework or hang from a parasol.



More Structures from Gala Tent

The Original Gala Tent PE

Available in over 17 different sizes from 2m x 3m to 6m x 12m
You can now purchase an-add on extension bay to extent your existing Gala Tent and make a bigger area.



Gala Tent Lining

Photo showing how 3m and 4m Gala tents look featuring lining. Turn your occasion in to a spectacular event with our fire rated very affordable quality ivory satin linings.



The New PVC Gala Tent

Featuring new 650g PVC materials featuring wave drape design and galvanised framework, available in over 17 different sizes from 2m x 3m to 6m x 12m. Available in White.



Check out the new 6m modular linings in this photo on the right.



Gala Shade Pro-MX

The new Gala Shade Pro-MX has been specifically designed to meet the requirements of the commercial market. It has an easy-up fast build mechanism and can be quickly erected by two people. Totally portable, Gala Shade Pro-MX is extremely robust and durable to withstand the bump and grind of regular use. Steel 1.2mm framework, 500g roof and optional sidewalls, available in many different colours and sizes, along with printing and branding service.



Gala Shade Pro-40

Gala Shade Pro-40 is Gala's mid range heavy-duty gazebo for commercial applications. Quality build the design balances exceptional durability and strength, practicality and value-for-money. Aluminium 1.8mm 40mm hexagonal framework, 500g roof and optional sidewalls, available in many different colours and sizes, along with printing and branding service.



© Intellectual property of Gala Tent Ltd

Gala Shade Pro-50

Gala Shade Pro-50 is Gala's top of the range heavy-duty gazebo for commercial applications. Quality build the design balances exceptional durability and strength, practicality and value-for-money. Aluminium 2mm 50mm hexagonal framework, 500g roof and optional sidewalls, available in many different colours and sizes, along with printing and branding service.



© Intellectual property of Gala Tent Ltd

9m x 9m Gala Fusion

The frames of clearspan Gala Fusion structures are manufactured from high-grade aluminium extrusions to provide strength whilst minimising weight; there is no need for centre supports or guide ropes. Gala Tent Fusion can be located on most surfaces including tarmac, concrete and grass. The lightweight frame makes Gala Tent Fusion quick simple and safe to erect with no special skills or tools required. Packs down to fit on an oversized pallet for easy transportation, also available in 3m, 4m and 6m with add on bays.



© Intellectual property of Gala Tent Ltd

Gala Tent Modular

Bespoke - manufactured to any size of your requirements

The clearspan high-reinforced aluminium framed marquee

* Canopy is made of 750g/ M2 blackout PVC-coated polyester textile.

* Sidewalls are made of 650g/M2 translucent PVC-coated polyester textile.

* Flame retardant



Contact Information

Address

Unit 10 Farfield Park
Manvers Way
Wath-Upon-Dearne
Rotherham
South Yorkshire
S63 5DB

Contact Telephone

0800 988 4252
0871 423 4252

For more information visit us

www.galalent.co.uk

